

SECTION VIEW

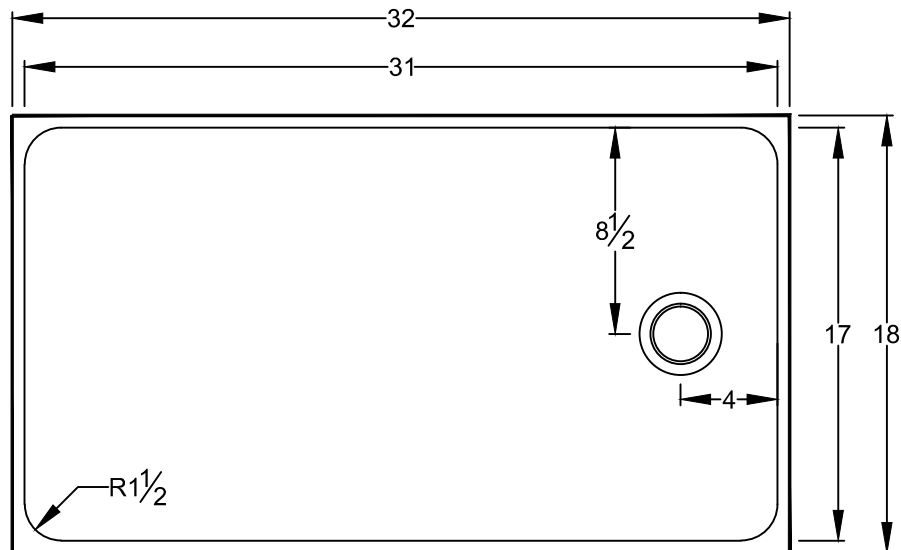

TOP VIEW

SINK MOLDED FROM EPOXY RESIN

SINK COLOR:

BLACK - OTHER: _____

THIS SINK SHIPS FROM
TAYLOR, TX 76574

Pii PRIME industries inc.

4611 Main St.
Lisle, IL 60532
ph: 630/725-9200 - fax: 630/725-9201
www.piilab.com

REV. DATE
12/11/14

WEIGHT
75 lbs.

SINK MODEL
P63