

MOD-RACK™ stainless steel pegboard

Model # V1824

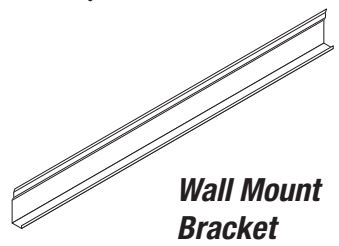
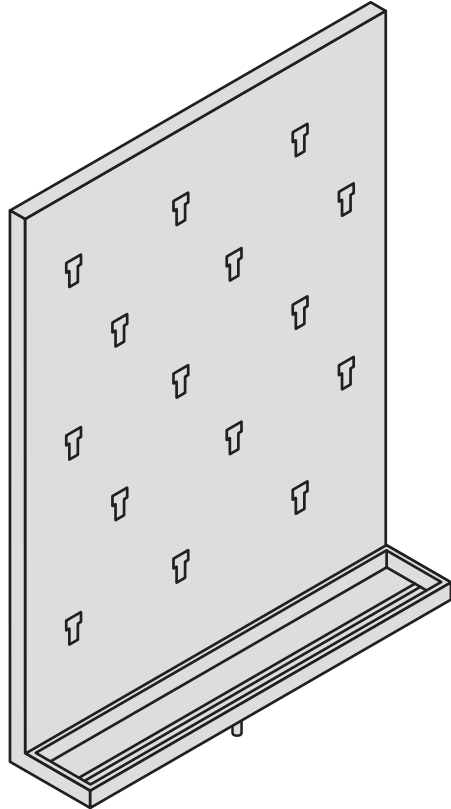

Wall Mount Bracket

"V" Victoria Series

V series pegboards have a catch drain and integral drip trough in 2" or 4" depth. All drip troughs come with a 36" clear flexible drain tube.

Features

- 18" w x 24" h x 3/4" d
- 15- 6" long 1/2" diameter white polypropylene pegs
- Autoclavable
- Constructed from 20 gauge, type 304 stainless steel, polished to a #4 finish.
- Wall mount bracket shipped with each pegboard.

Standard Peg

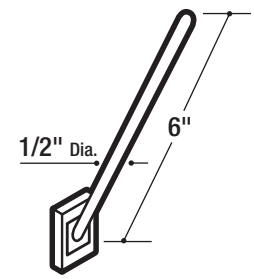

Product Dimensions

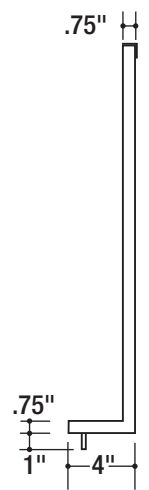
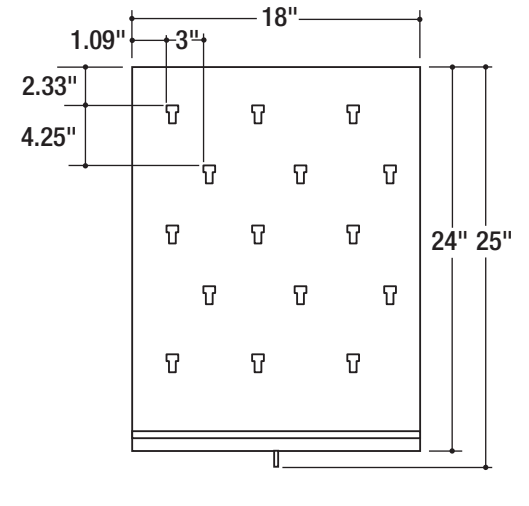
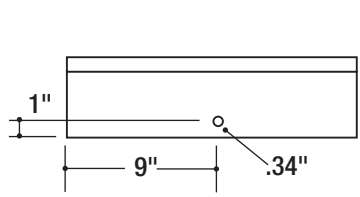

MOD-RACK™ stainless steel pegboard

Model # V2418

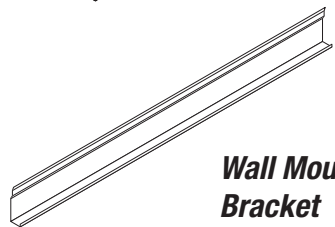
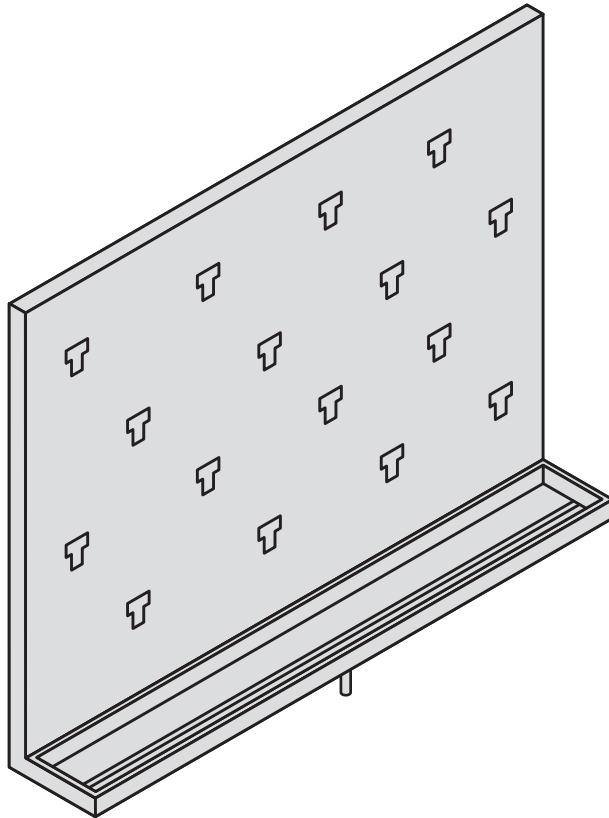

**Wall Mount
Bracket**

"V" Victoria Series

V series pegboards have a catch drain and integral drip trough in 2" or 4" depth. All drip troughs come with a 36" clear flexible drain tube.

Features

- 24" w x 18" h x 3/4" d
- 16- 6" long 1/2" diameter white polypropylene pegs
- Autoclavable
- Constructed from 20 gauge, type 304 stainless steel, polished to a #4 finish.
- Wall mount bracket shipped with each pegboard.

Standard Peg

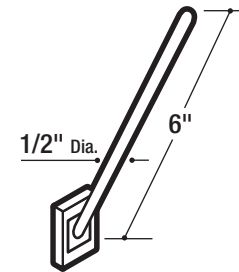

Product Dimensions

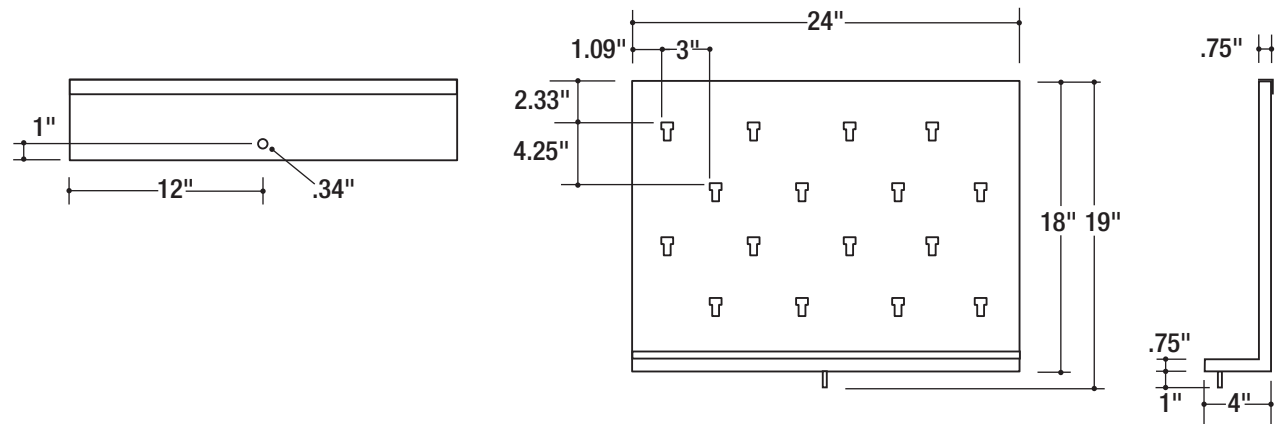

INTER DYNE
systems, inc
STAINLESS STEEL LABORATORY SYSTEMS

Inter Dyne Systems, Inc.
676 Ellis Road, Norton Shores, MI 49441
Ph: 877.4ss.labs
www.interdynesystems.com

MOD-RACK™ stainless steel pegboard

Model # V2424

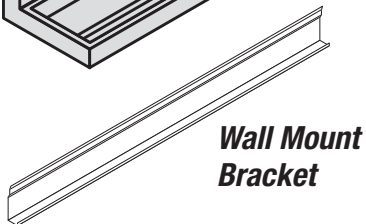
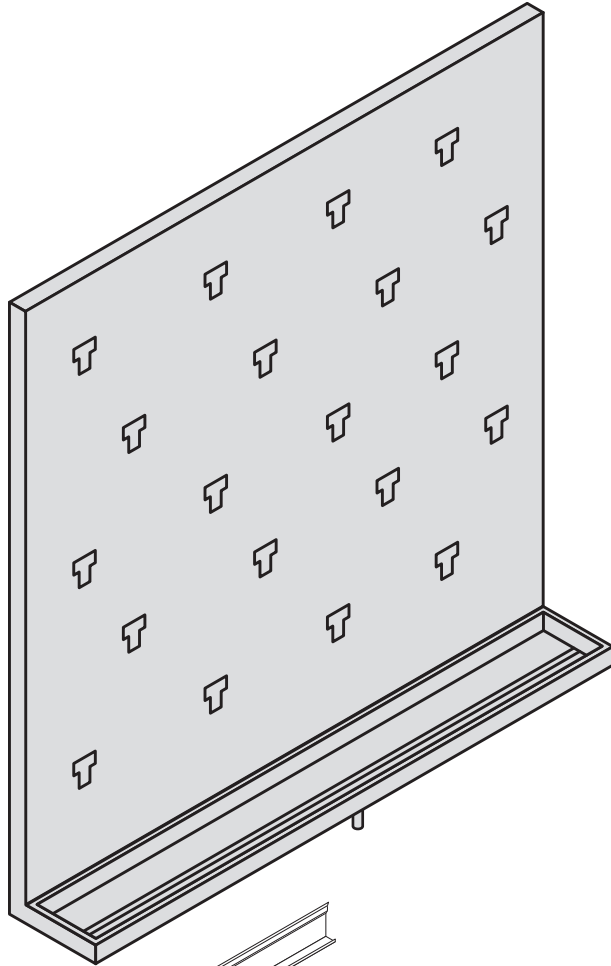

"V" Victoria Series

V series pegboards have a catch drain and integral drip trough in 2" or 4" depth. All drip troughs come with a 36" clear flexible drain tube.

Features

- 24" w x 24" h x 3/4" d
- 20- 6" long 1/2" diameter white polypropylene pegs
- Autoclavable
- Constructed from 20 gauge, type 304 stainless steel, polished to a #4 finish.
- Wall mount bracket shipped with each pegboard.

Standard Peg

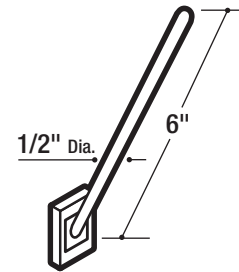

Product Dimensions

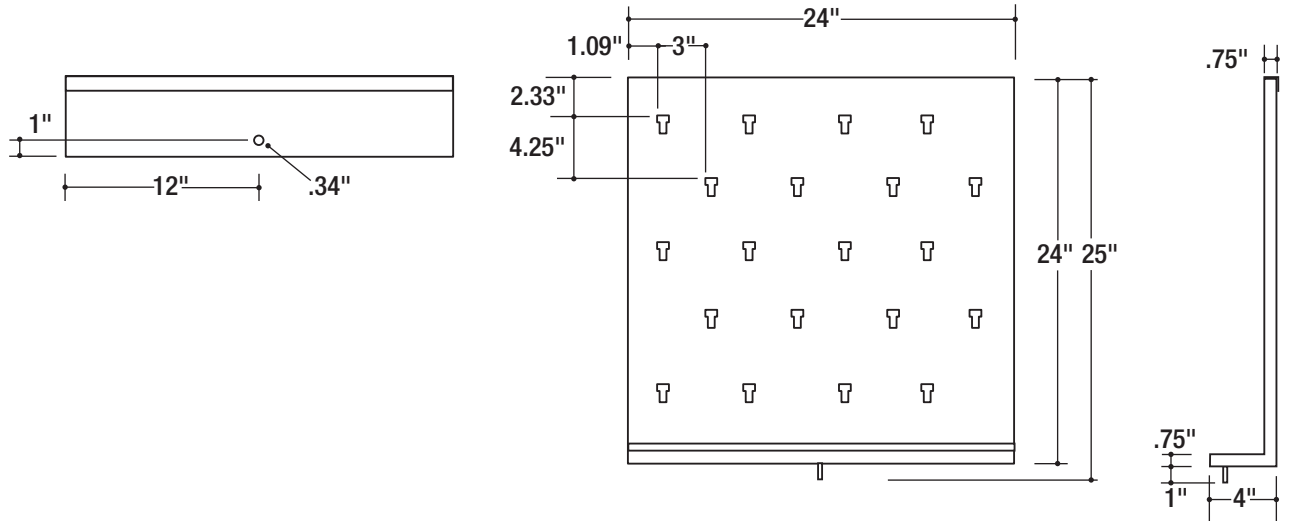

MOD-RACK™ stainless steel pegboard

Model # V2430

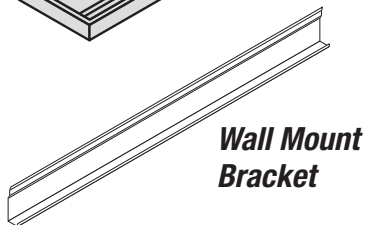
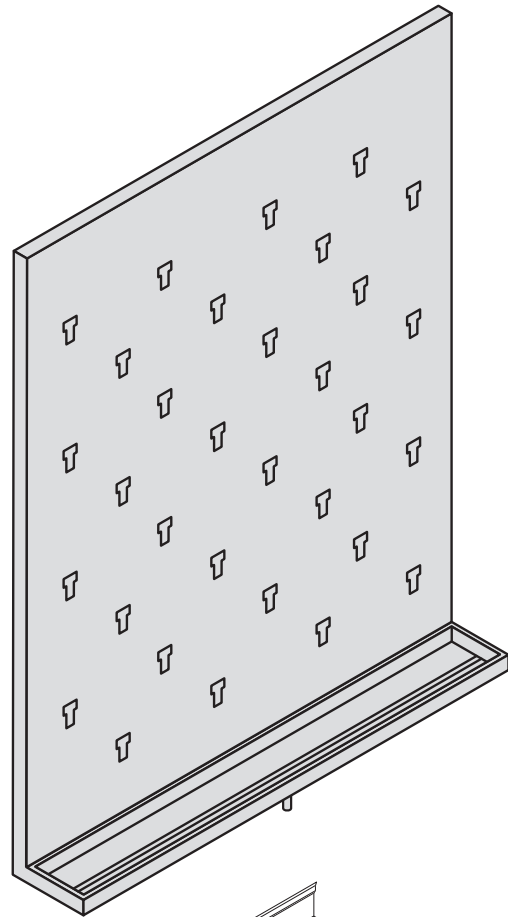

"V" Victoria Series

V series pegboards have a catch drain and integral drip trough in 2" or 4" depth. All drip troughs come with a 36" clear flexible drain tube.

Features

- 24" w x 30" h x 3/4" d
- 32- 6" long 1/2" diameter white polypropylene pegs
- Autoclavable
- Constructed from 20 gauge, type 304 stainless steel, polished to a #4 finish.
- Wall mount bracket shipped with each pegboard.

Standard Peg

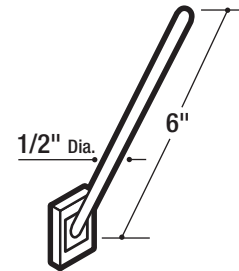

Product Dimensions

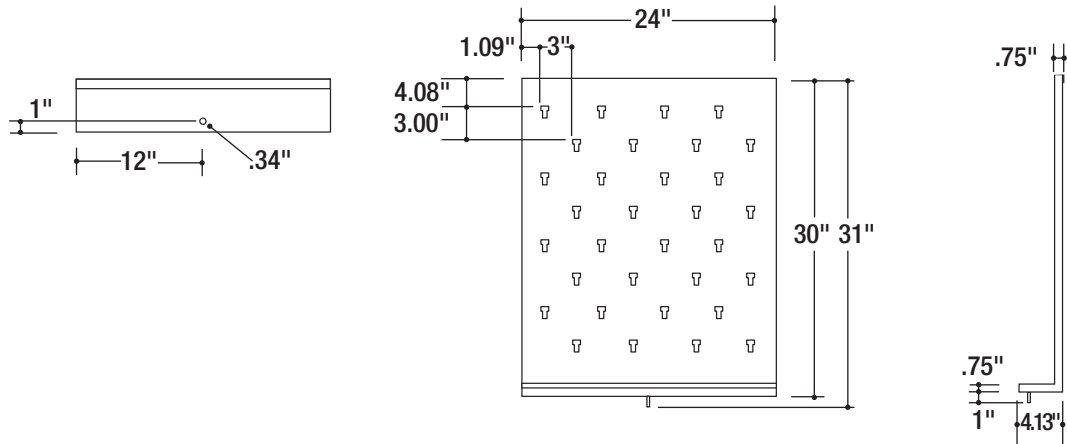

INTER DYNE
systems, inc
STAINLESS STEEL LABORATORY SYSTEMS

Inter Dyne Systems, Inc.
676 Ellis Road, Norton Shores, MI 49441
Ph: 877.4ss.labs
www.interdynesystems.com

MOD-RACK™ stainless steel pegboard

Model # V2436

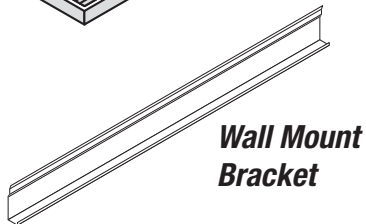
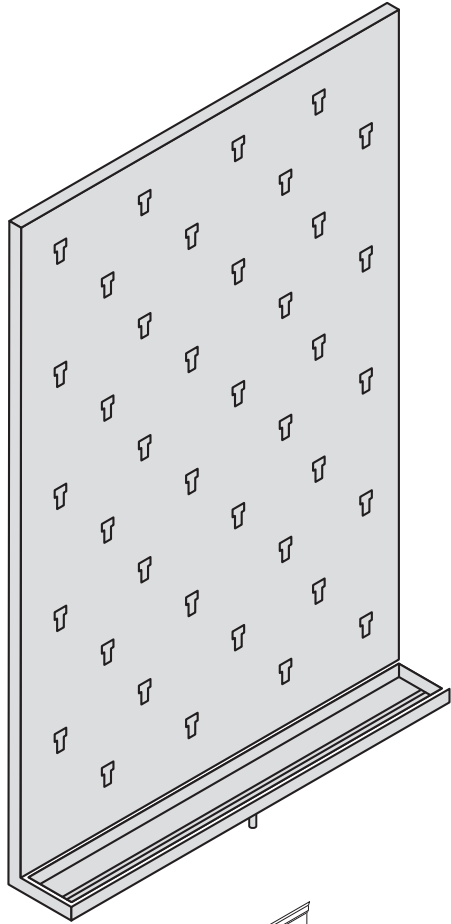

"V" Victoria Series

V series pegboards have a catch drain and integral drip trough in 2" or 4" depth. All drip troughs come with a 36" clear flexible drain tube.

Features

- 24" w x 36" h x 3/4" d
- 40- 6" long 1/2" diameter white polypropylene pegs
- Autoclavable
- Constructed from 20 gauge, type 304 stainless steel, polished to a #4 finish.
- Wall mount bracket shipped with each pegboard.

Standard Peg

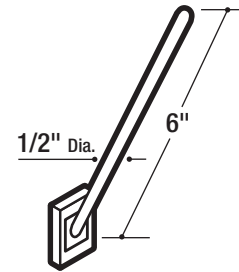

Product Dimensions

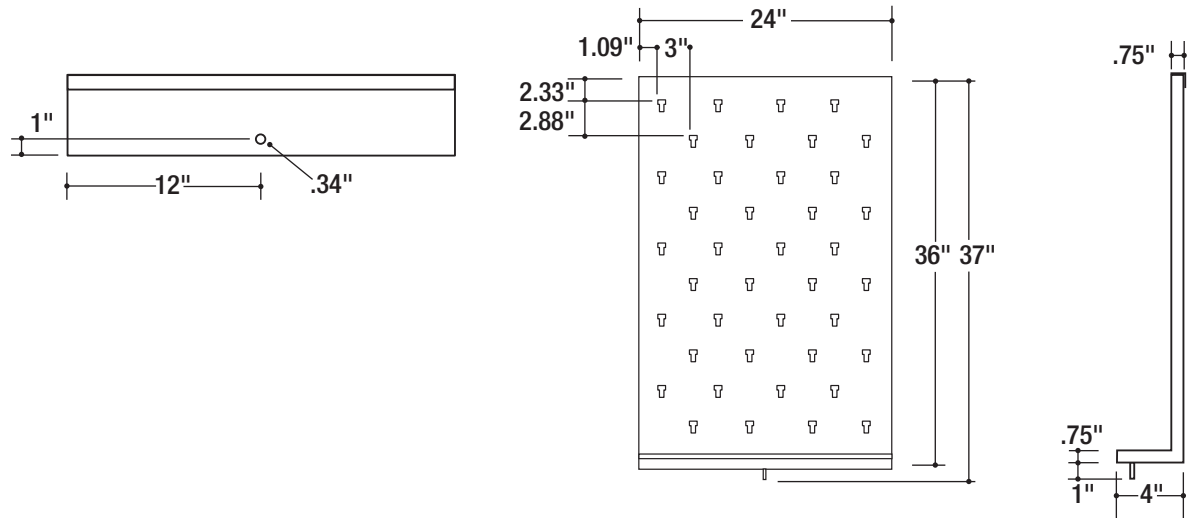

MOD-RACK™ stainless steel pegboard

Model # V3024

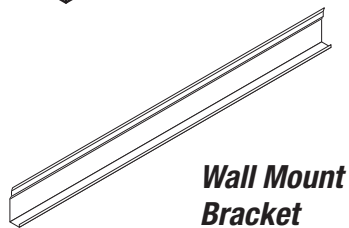
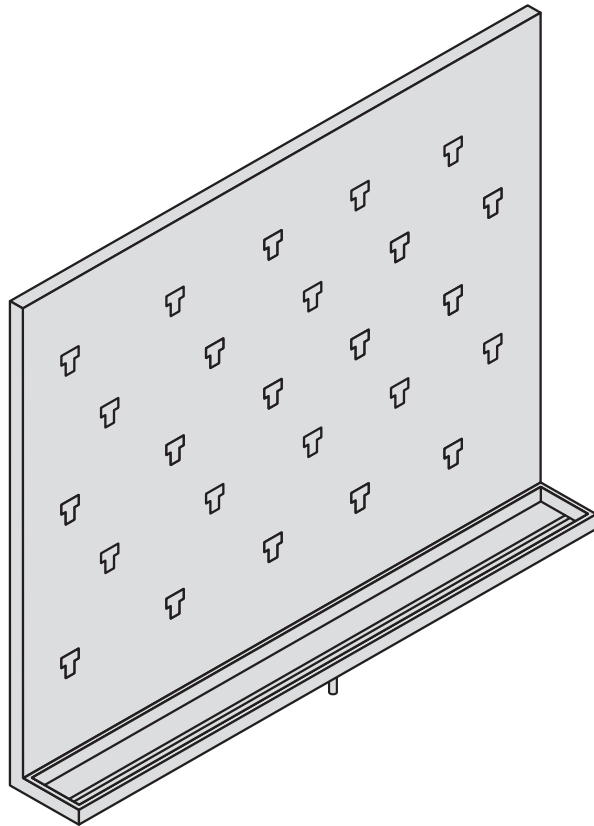

"V" Victoria Series

V series pegboards have a catch drain and integral drip trough in 2" or 4" depth. All drip troughs come with a 36" clear flexible drain tube.

Features

- 30" w x 24" h x 3/4" d
- 25- 6" long 1/2" diameter white polypropylene pegs
- Autoclavable
- Constructed from 20 gauge, type 304 stainless steel, polished to a #4 finish.
- Wall mount bracket shipped with each pegboard.

Standard Peg

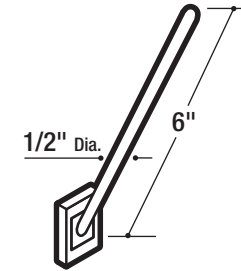

Product Dimensions

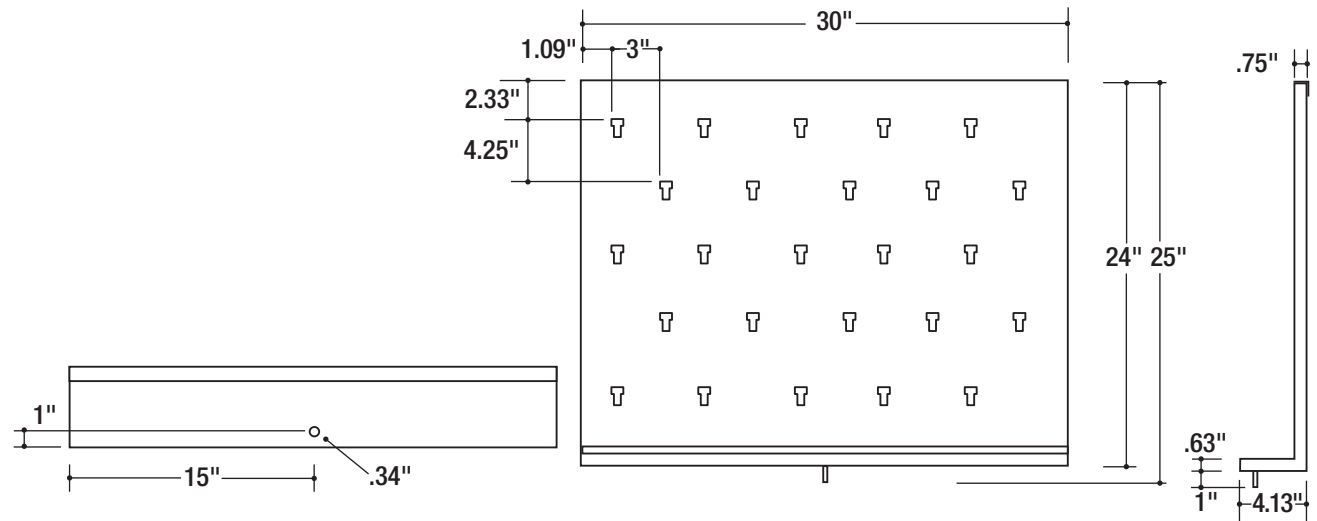

MOD-RACK™ stainless steel pegboard

Model # V3030

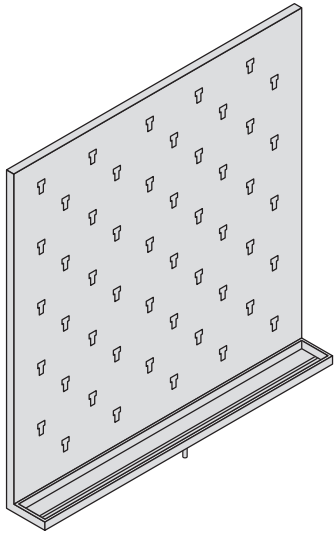

"V" Victoria Series

V series pegboards have a catch drain and integral drip trough in 2" or 4" depth. All drip troughs come with a 36" clear flexible drain tube.

Features

- 30" w x 30" h x 3/4" d
- 50- 6" long 1/2" diameter white polypropylene pegs
- Autoclavable
- Constructed from 20 gauge, type 304 stainless steel, polished to a #4 finish.
- Wall mount bracket shipped with each pegboard.

Standard Peg

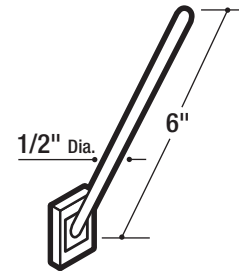

Product Dimensions

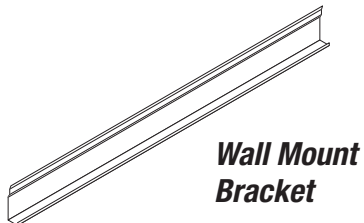
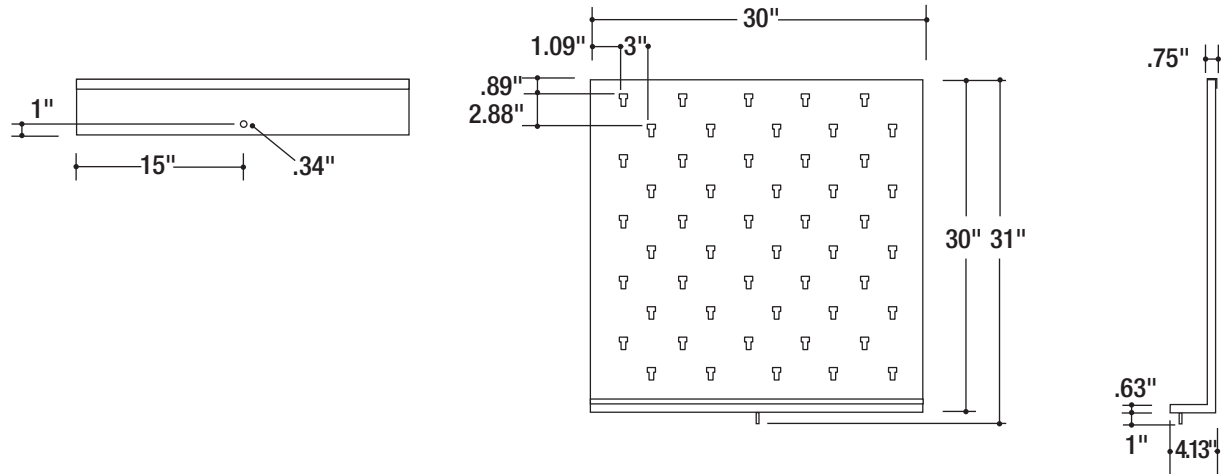

MOD-RACK™ stainless steel pegboard

Model # V3036

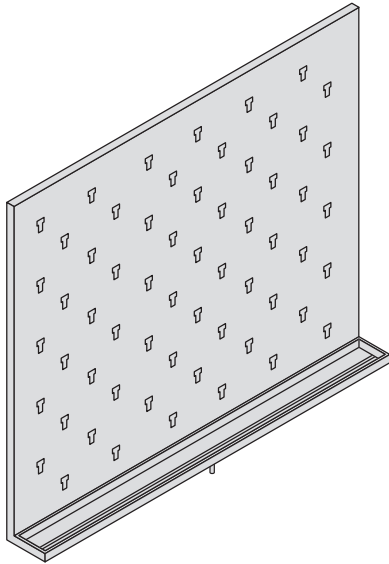

"V" Victoria Series

V series pegboards have a catch drain and integral drip trough in 2" or 4" depth. All drip troughs come with a 36" clear flexible drain tube.

Features

- 30" w x 36" h x 3/4" d
- 40- 6" long 1/2" diameter white polypropylene pegs
- Autoclavable
- Constructed from 20 gauge, type 304 stainless steel, polished to a #4 finish.
- Wall mount bracket shipped with each pegboard.

Standard Peg

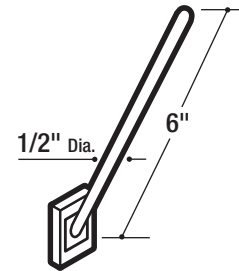

Product Dimensions

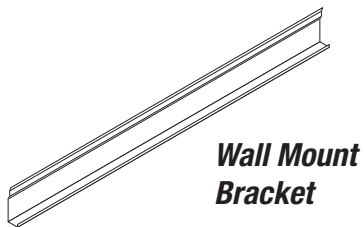
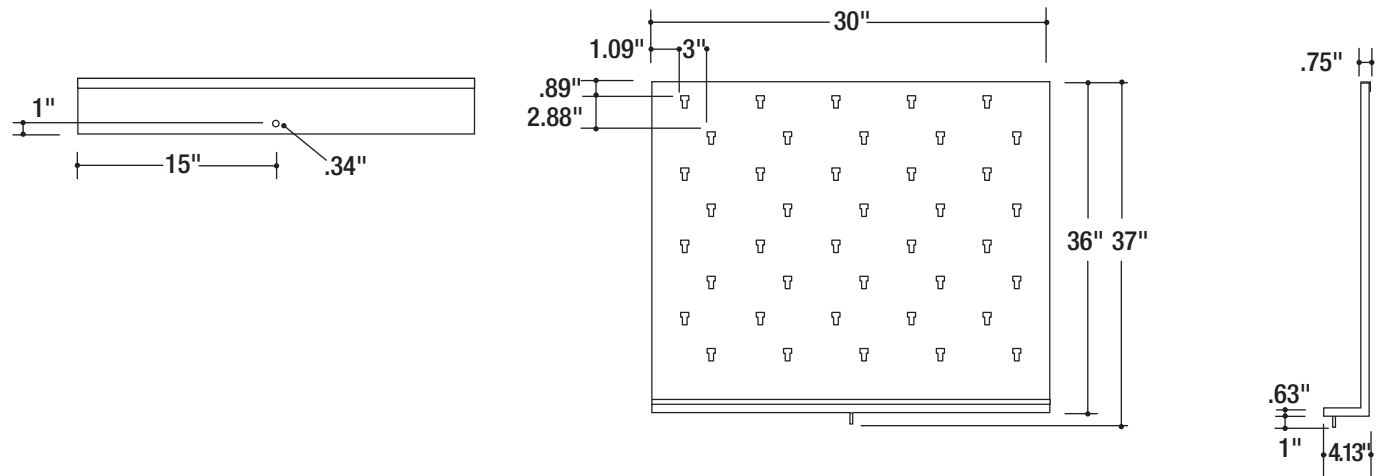

MOD-RACK™ stainless steel pegboard

Model # V3624

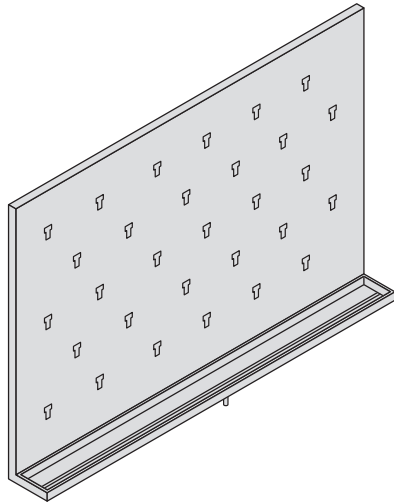

"V" Victoria Series

V series pegboards have a catch drain and integral drip trough in 2" or 4" depth. All drip troughs come with a 36" clear flexible drain tube.

Features

- 36" w x 24" h x 3/4" d
- 30- 6" long 1/2" diameter white polypropylene pegs
- Autoclavable
- Constructed from 20 gauge, type 304 stainless steel, polished to a #4 finish.
- Wall mount bracket shipped with each pegboard.

Standard Peg

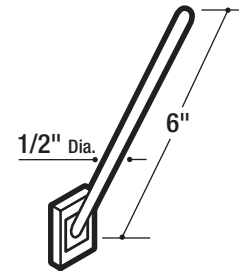

Product Dimensions

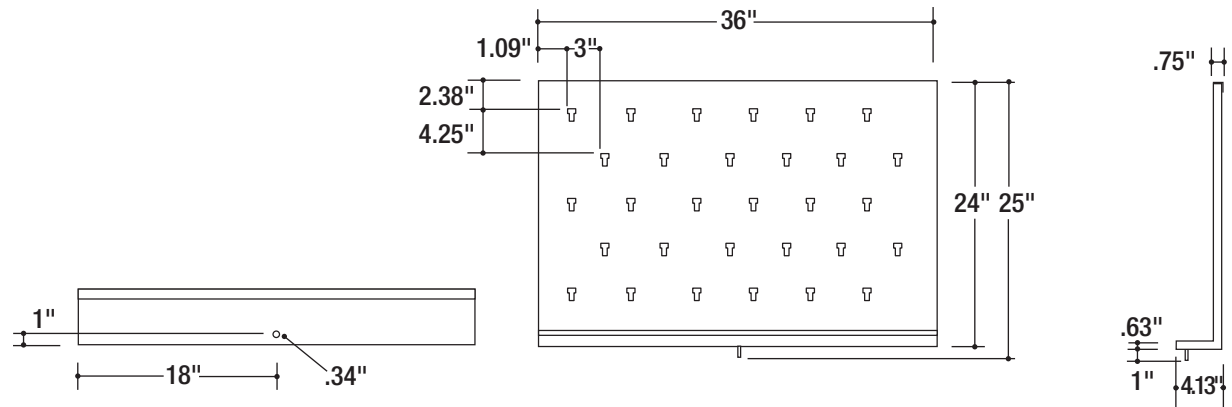
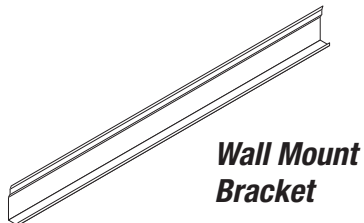

MOD-RACK™ stainless steel pegboard

Model # V3630

"V" Victoria Series

V series pegboards have a catch drain and integral drip trough in 2" or 4" depth. All drip troughs come with a 36" clear flexible drain tube.

Features

- 36" w x 30" h x 3/4" d
- 60- 6" long 1/2" diameter white polypropylene pegs
- Autoclavable
- Constructed from 20 gauge, type 304 stainless steel, polished to a #4 finish.
- Wall mount bracket shipped with each pegboard.

Standard Peg

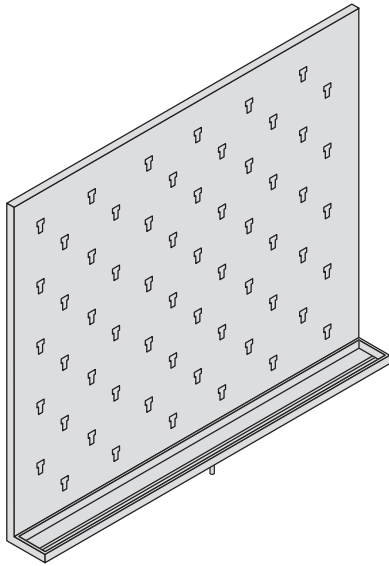
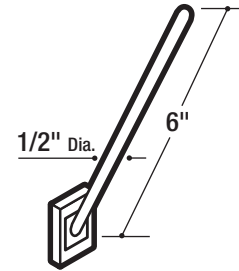

Product Dimensions

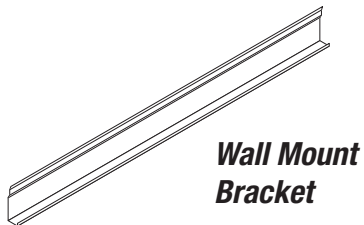
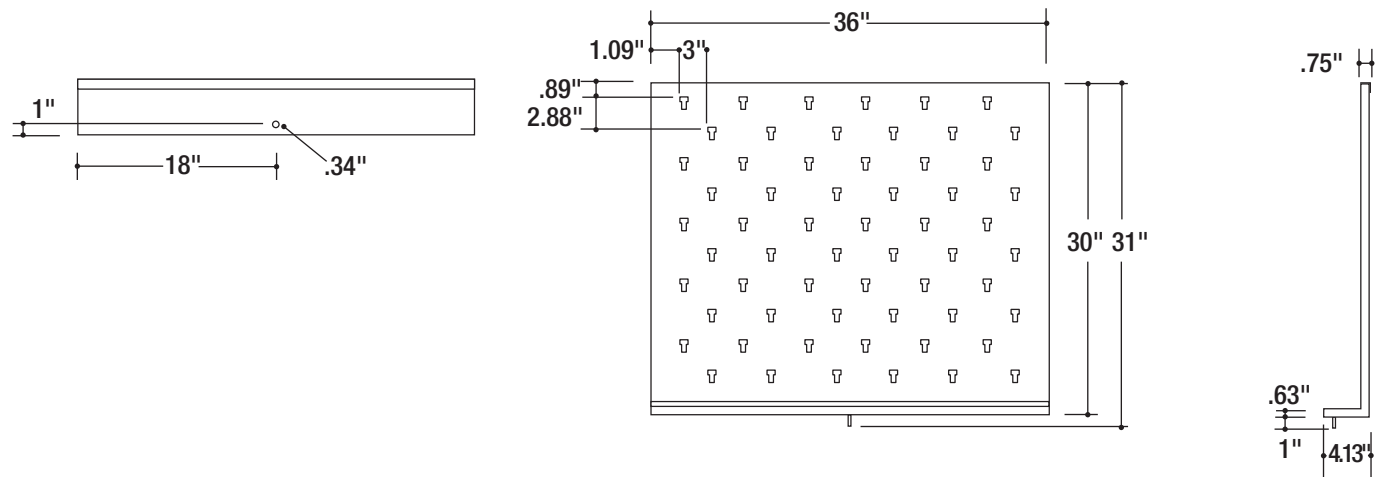

MOD-RACK™ stainless steel pegboard

Model # V3636

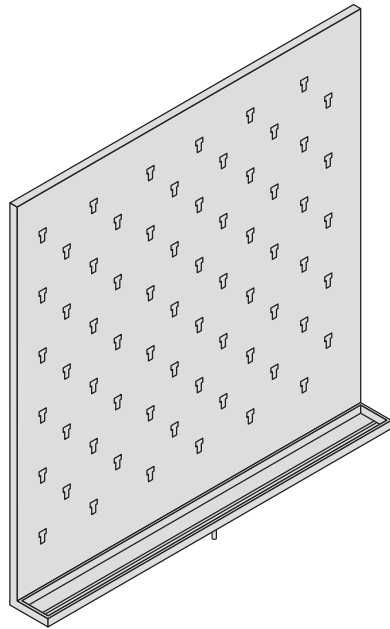

"V" Victoria Series

V series pegboards have a catch drain and integral drip trough in 2" or 4" depth. All drip troughs come with a 36" clear flexible drain tube.

Features

- 36" w x 36" h x 3/4" d
- 66- 6" long 1/2" diameter white polypropylene pegs
- Autoclavable
- Constructed from 20 gauge, type 304 stainless steel, polished to a #4 finish.
- Wall mount bracket shipped with each pegboard.

Standard Peg

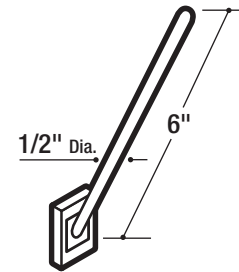

Product Dimensions

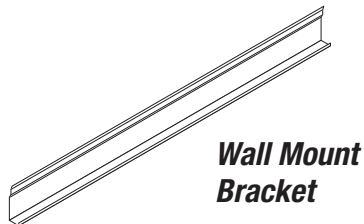
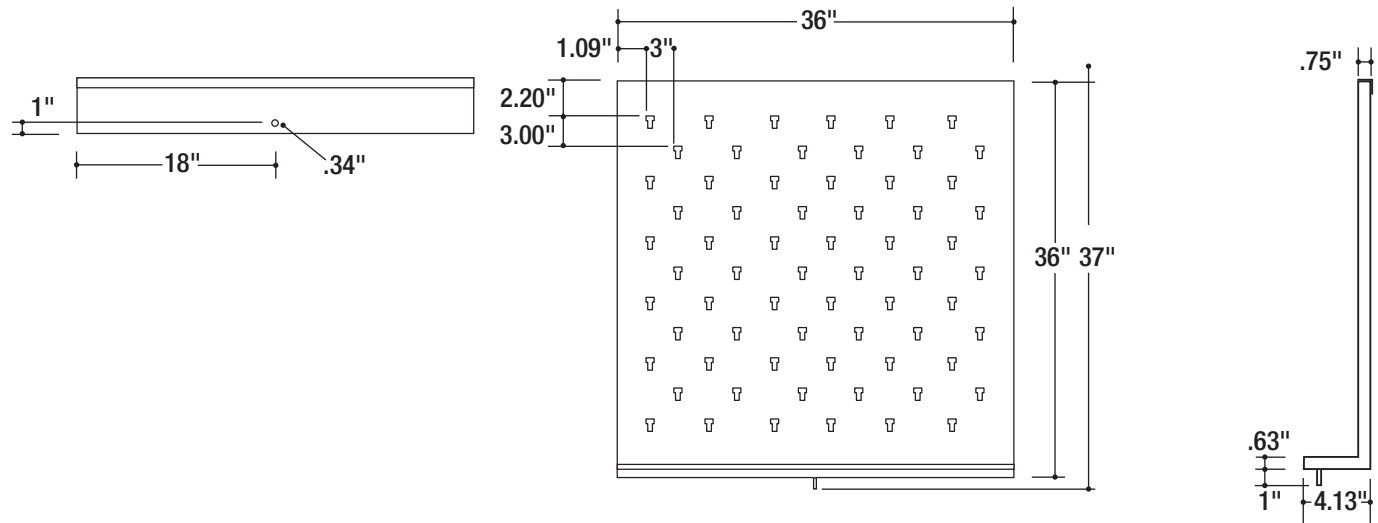

INTER DYNE
systems, inc
STAINLESS STEEL LABORATORY SYSTEMS

Inter Dyne Systems, Inc.
676 Ellis Road, Norton Shores, MI 49441
Ph: 877.4ss.labs
www.interdynesystems.com

MOD-RACK™ stainless steel pegboard

Model # V4824

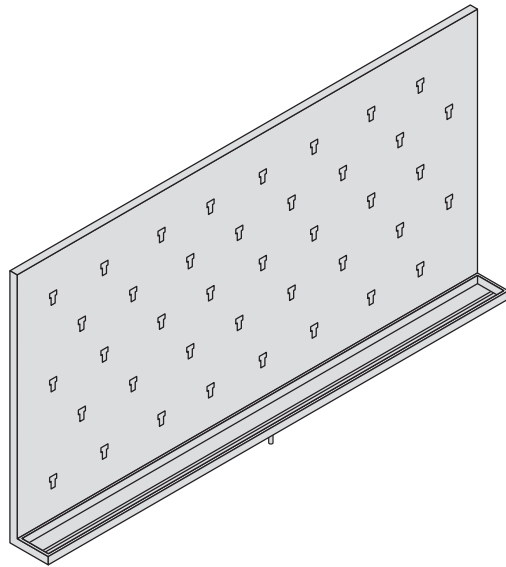

"V" Victoria Series

V series pegboards have a catch drain and integral drip trough in 2" or 4" depth. All drip troughs come with a 36" clear flexible drain tube.

Features

- 48" w x 24" h x 3/4" d
- 40- 6" long 1/2" diameter white polypropylene pegs
- Autoclavable
- Constructed from 20 gauge, type 304 stainless steel, polished to a #4 finish.
- Wall mount bracket shipped with each pegboard.

Standard Peg

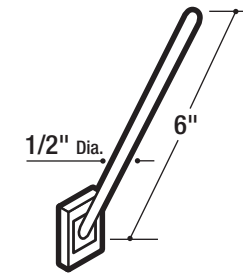

Product Dimensions

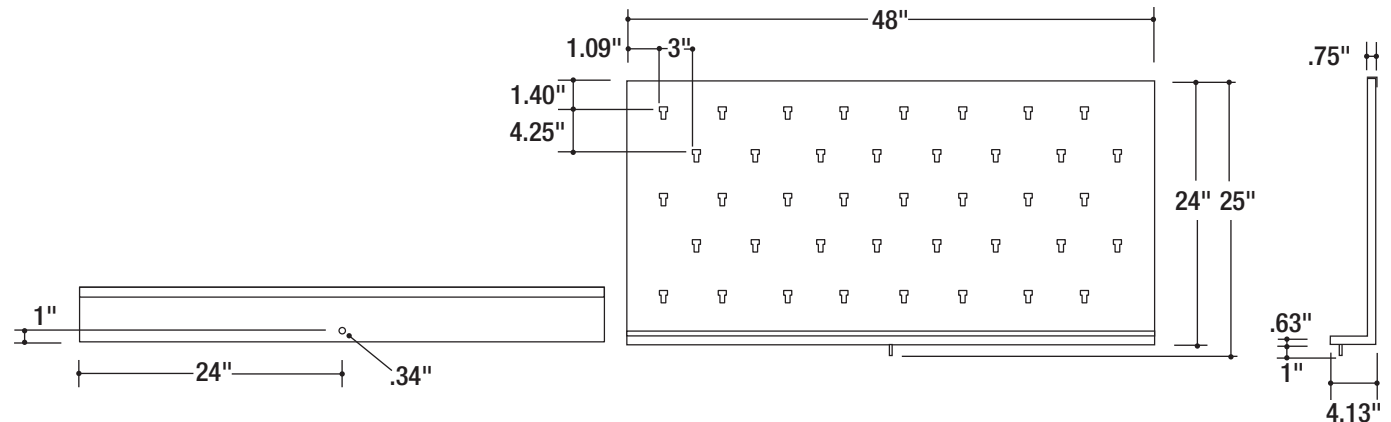
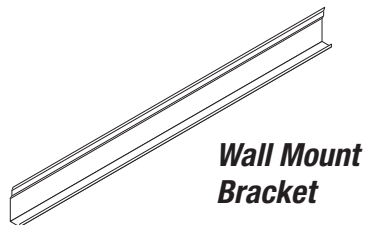

MOD-RACK™ stainless steel pegboard

Model # V4830

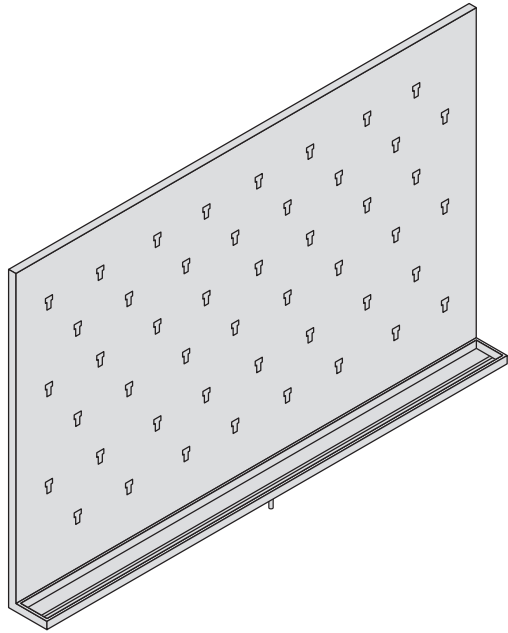

"V" Victoria Series

V series pegboards have a catch drain and integral drip trough in 2" or 4" depth. All drip troughs come with a 36" clear flexible drain tube.

Features

- 48" w x 30" h x 3/4" d
- 48- 6" long 1/2" diameter white polypropylene pegs
- Autoclavable
- Constructed from 20 gauge, type 304 stainless steel, polished to a #4 finish.
- Wall mount bracket shipped with each pegboard.

Standard Peg

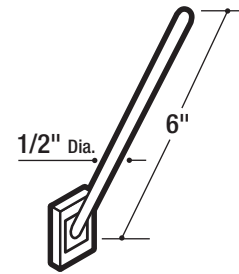

Product Dimensions

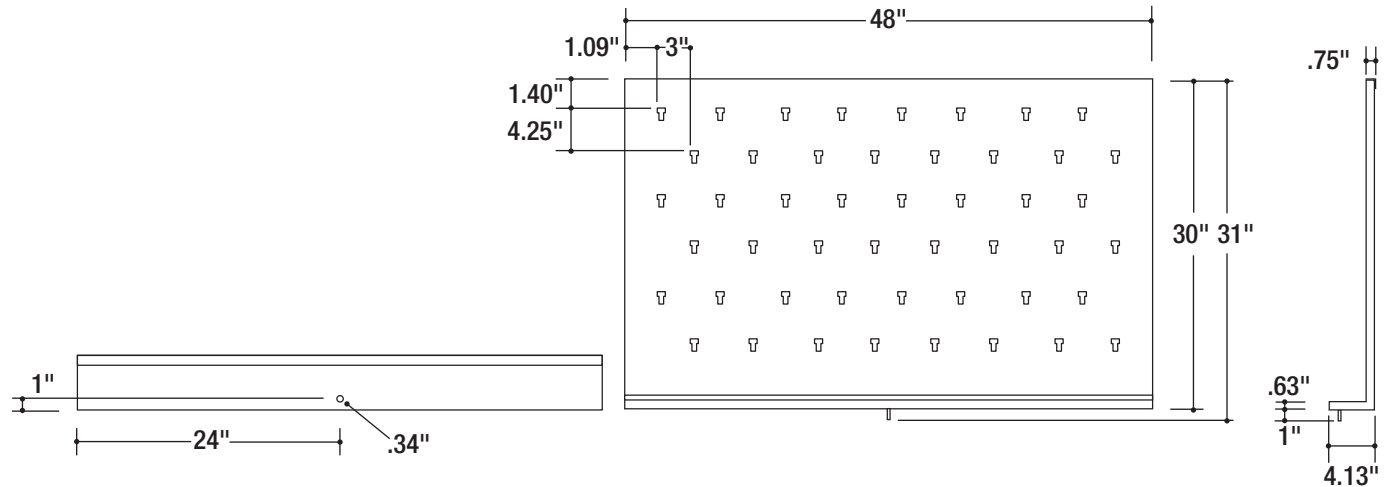
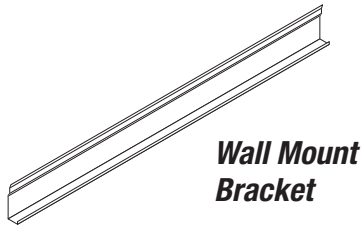

MOD-RACK™ stainless steel pegboard

Model # V4836

"V" Victoria Series

V series pegboards have a catch drain and integral drip trough in 2" or 4" depth. All drip troughs come with a 36" clear flexible drain tube.

Features

- 48" w x 36" h x 3/4" d
- 88- 6" long 1/2" diameter white polypropylene pegs
- Autoclavable
- Constructed from 20 gauge, type 304 stainless steel, polished to a #4 finish.
- Wall mount bracket shipped with each pegboard.

Standard Peg

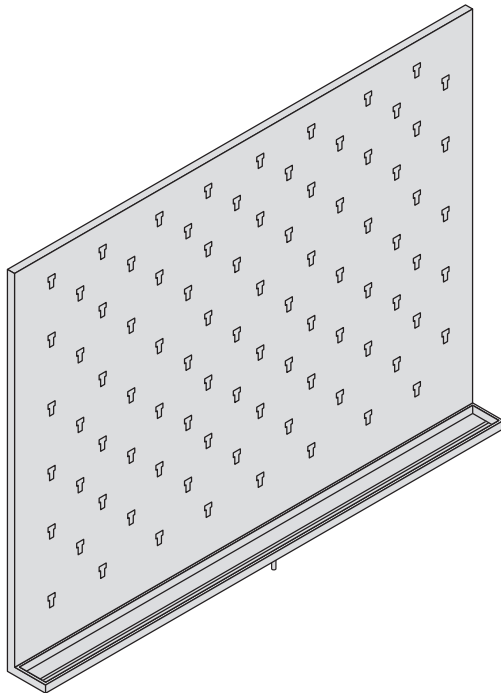
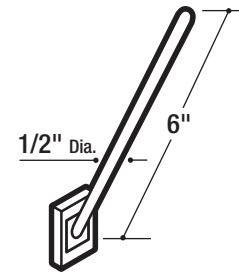

Product Dimensions

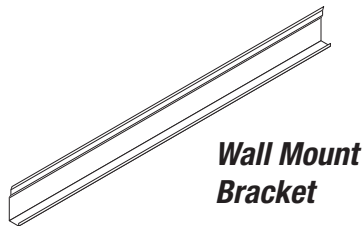

Wall Mount Bracket

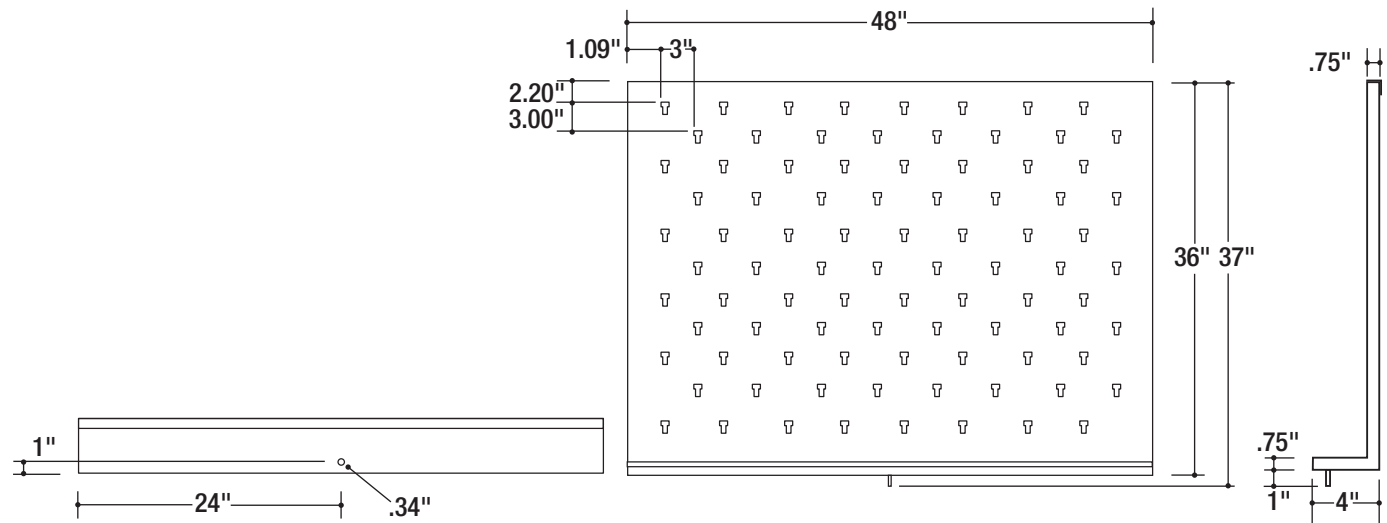

INTER DYNE
systems, inc
STAINLESS STEEL LABORATORY SYSTEMS

Inter Dyne Systems, Inc.
676 Ellis Road, Norton Shores, MI 49441
Ph: 877.4ss.labs
www.interdynesystems.com